



**SPECIFICATION
FOR
LCD Module
PV08002TD25E-C**

MODULE:	PV08002TD25E-C
CUSTOMER:	

KINGTECH	INITIAL	DATE
PREPARED BY		2019-9-17
CHECKED BY		2019-9-17
APPROVED BY		2019-9-17

CUSTOMER	INITIAL	DATE
APPROVED BY		



REVISION STATUS

Version	Revise Date	Page	Content	Modified by
V1.0	2019-9-17	-	First Issued.	YANG



TABLE OF CONTENTS

1.General Description

2. Mechanical Characteristics

3. Pin Description

4. Electrical Characteristics

5. Optical Characteristics

6. Quality Specifications

7. Reliability

8. Handling Precaution



1. General Description

* DESCRIPTION

PV08002TD25E-C is a color active matrix TFT (Thin Film Transistor) LCD (liquid crystal display) that uses amorphous silicon TFT as a switching device. This model is composed of a Transmissive type TFT-LCD Panel, driver circuit, back-light unit. The resolution of a 8.0" TFT-LCD contains 800 x 1280 pixels, and can display up to 16.7M colors.

* Features

- Low Input Voltage: VCC: 2.5~3.3V
- Display Colors of TFT LCD: 16.7M colors
- Interface: MIPI-4 Lanes
- Internal Power Supply Circuit.

General Information Items	Specification	Unit	Note
	Main Panel		
Display area(AA)	107.64(H) *172.22(V) (8.0inch)	mm	-
Driver element	a-Si TFT active matrix	-	-
Display colors	16.7M	colors	-
Number of pixels	800(RGB) *1280	dots	-
Pixel arrangement	RGB vertical stripe	-	-
Pixel pitch	0.13455(H) *0.13455(V)	mm	-
Viewing angle	All	o'clock	-
Drive IC	JD9366	-	-
Display mode	Normally black	-	-
Operating temperature	-10~+60	°C	-
Storage temperature	-20~+70	°C	-

Mechanical Information

Item		Min.	Typ.	Max.	Unit	Note
Module size	Horizontal(H)	-	125.6	-	mm	±0.1
	Vertical(V)	-	231.6	-	mm	±0.1
	Depth(D)	-	4.86	-	mm	±0.3
Weight		-	TBD	-	g	-



2. MECHANICAL SPECIFICATION

<p>一. 产品特点 (Features):</p> <p>1. 产品规格:</p> <p>(Product specifications):</p> <table border="1" style="width:100%; border-collapse: collapse;"> <tr> <td>显示类型 (Display mode):</td> <td>FTI/Normal BLACK</td> </tr> <tr> <td>驱动芯片 (Driver IC):</td> <td>D993861B</td> </tr> <tr> <td>人脸解锁角 (Unlocking Direction):</td> <td>ALL</td> </tr> <tr> <td>接口类型 (Interface Types):</td> <td>MPI 4 LANE</td> </tr> <tr> <td>背光源 (Backlight Types):</td> <td>2ips, 3#7并140mA(20mA/LED) 电压为9.6V(TYP)</td> </tr> <tr> <td>模组亮度 (LCM Brightness):</td> <td>300cd/m2 Min, 380cd/m2 TYP</td> </tr> <tr> <td>模组色坐标 (cm color coordinates):</td> <td>(X=0.29±0.05, Y=0.30±0.05)</td> </tr> <tr> <td>模组均匀度 (LCM Uniformity):</td> <td>80% MIN</td> </tr> <tr> <td>操作温度 (Operating Temperature):</td> <td>-10°C~60°C</td> </tr> <tr> <td>储存温度 (Storage Temperature):</td> <td>-20°C~70°C</td> </tr> <tr> <td>平面翘曲度 (Plane Warpage Degree):</td> <td><0.3MM</td> </tr> <tr> <td>连接器 (PC connector):</td> <td>---</td> </tr> </table>	显示类型 (Display mode):	FTI/Normal BLACK	驱动芯片 (Driver IC):	D993861B	人脸解锁角 (Unlocking Direction):	ALL	接口类型 (Interface Types):	MPI 4 LANE	背光源 (Backlight Types):	2ips, 3#7并140mA(20mA/LED) 电压为9.6V(TYP)	模组亮度 (LCM Brightness):	300cd/m2 Min, 380cd/m2 TYP	模组色坐标 (cm color coordinates):	(X=0.29±0.05, Y=0.30±0.05)	模组均匀度 (LCM Uniformity):	80% MIN	操作温度 (Operating Temperature):	-10°C~60°C	储存温度 (Storage Temperature):	-20°C~70°C	平面翘曲度 (Plane Warpage Degree):	<0.3MM	连接器 (PC connector):	---	<p>二. CTP技术要求 (CTP Technical requirements)</p> <p>CTP技术要求:</p> <ol style="list-style-type: none"> 1. 结构为:G+G; 2. IC:GT911, 通道数14*24, 工作电压2.8V, 通讯电压: 1.8V; 3. 盖板表面硬度: ≥6H; 4. 成品可视区透光率, ≥85%; 5. 操作环境: -20°C~+70°C, ≤90%RH; 储存环境: -30°C~+80°C, ≤90%RH; 6. 所有材料符合RoHS标准; 7. 公差±0.2. 	<p>丝印效果图</p>	<p>侧视图</p>	<p>背视图</p>	<table border="1" style="width:100%; border-collapse: collapse;"> <tr> <th>PIN</th> <th>SYMBOL</th> </tr> <tr> <td>1</td> <td>VDD_3.3</td> </tr> <tr> <td>2</td> <td>VDD_3.3</td> </tr> <tr> <td>3</td> <td>RST</td> </tr> <tr> <td>4</td> <td>GND</td> </tr> <tr> <td>5</td> <td>MPI1_ON</td> </tr> <tr> <td>6</td> <td>MPI1_OP</td> </tr> <tr> <td>7</td> <td>GND</td> </tr> <tr> <td>8</td> <td>MPI1_IN</td> </tr> <tr> <td>9</td> <td>MPI1_IP</td> </tr> <tr> <td>10</td> <td>GND</td> </tr> <tr> <td>11</td> <td>MPI1_CKN</td> </tr> <tr> <td>12</td> <td>MPI1_CKP</td> </tr> <tr> <td>13</td> <td>GND</td> </tr> <tr> <td>14</td> <td>MPI1_2N</td> </tr> <tr> <td>15</td> <td>MPI1_2P</td> </tr> <tr> <td>16</td> <td>GND</td> </tr> <tr> <td>17</td> <td>MPI1_3N</td> </tr> <tr> <td>18</td> <td>MPI1_3P</td> </tr> <tr> <td>19</td> <td>GND</td> </tr> <tr> <td>20</td> <td>PMIO</td> </tr> <tr> <td>21</td> <td>GND</td> </tr> <tr> <td>22</td> <td>LED-</td> </tr> <tr> <td>23</td> <td>LED-</td> </tr> <tr> <td>24</td> <td>LED+</td> </tr> <tr> <td>25</td> <td>LED+</td> </tr> </table>	PIN	SYMBOL	1	VDD_3.3	2	VDD_3.3	3	RST	4	GND	5	MPI1_ON	6	MPI1_OP	7	GND	8	MPI1_IN	9	MPI1_IP	10	GND	11	MPI1_CKN	12	MPI1_CKP	13	GND	14	MPI1_2N	15	MPI1_2P	16	GND	17	MPI1_3N	18	MPI1_3P	19	GND	20	PMIO	21	GND	22	LED-	23	LED-	24	LED+	25	LED+																																																																																																																																																																																																																												
显示类型 (Display mode):	FTI/Normal BLACK																																																																																																																																																																																																																																																																																																												
驱动芯片 (Driver IC):	D993861B																																																																																																																																																																																																																																																																																																												
人脸解锁角 (Unlocking Direction):	ALL																																																																																																																																																																																																																																																																																																												
接口类型 (Interface Types):	MPI 4 LANE																																																																																																																																																																																																																																																																																																												
背光源 (Backlight Types):	2ips, 3#7并140mA(20mA/LED) 电压为9.6V(TYP)																																																																																																																																																																																																																																																																																																												
模组亮度 (LCM Brightness):	300cd/m2 Min, 380cd/m2 TYP																																																																																																																																																																																																																																																																																																												
模组色坐标 (cm color coordinates):	(X=0.29±0.05, Y=0.30±0.05)																																																																																																																																																																																																																																																																																																												
模组均匀度 (LCM Uniformity):	80% MIN																																																																																																																																																																																																																																																																																																												
操作温度 (Operating Temperature):	-10°C~60°C																																																																																																																																																																																																																																																																																																												
储存温度 (Storage Temperature):	-20°C~70°C																																																																																																																																																																																																																																																																																																												
平面翘曲度 (Plane Warpage Degree):	<0.3MM																																																																																																																																																																																																																																																																																																												
连接器 (PC connector):	---																																																																																																																																																																																																																																																																																																												
PIN	SYMBOL																																																																																																																																																																																																																																																																																																												
1	VDD_3.3																																																																																																																																																																																																																																																																																																												
2	VDD_3.3																																																																																																																																																																																																																																																																																																												
3	RST																																																																																																																																																																																																																																																																																																												
4	GND																																																																																																																																																																																																																																																																																																												
5	MPI1_ON																																																																																																																																																																																																																																																																																																												
6	MPI1_OP																																																																																																																																																																																																																																																																																																												
7	GND																																																																																																																																																																																																																																																																																																												
8	MPI1_IN																																																																																																																																																																																																																																																																																																												
9	MPI1_IP																																																																																																																																																																																																																																																																																																												
10	GND																																																																																																																																																																																																																																																																																																												
11	MPI1_CKN																																																																																																																																																																																																																																																																																																												
12	MPI1_CKP																																																																																																																																																																																																																																																																																																												
13	GND																																																																																																																																																																																																																																																																																																												
14	MPI1_2N																																																																																																																																																																																																																																																																																																												
15	MPI1_2P																																																																																																																																																																																																																																																																																																												
16	GND																																																																																																																																																																																																																																																																																																												
17	MPI1_3N																																																																																																																																																																																																																																																																																																												
18	MPI1_3P																																																																																																																																																																																																																																																																																																												
19	GND																																																																																																																																																																																																																																																																																																												
20	PMIO																																																																																																																																																																																																																																																																																																												
21	GND																																																																																																																																																																																																																																																																																																												
22	LED-																																																																																																																																																																																																																																																																																																												
23	LED-																																																																																																																																																																																																																																																																																																												
24	LED+																																																																																																																																																																																																																																																																																																												
25	LED+																																																																																																																																																																																																																																																																																																												
<p>FPC弯折示意图</p> <p>弯折出货</p>					<table border="1" style="width:100%; border-collapse: collapse;"> <tr> <th>PIN#</th> <th>定义</th> </tr> <tr> <td>1</td> <td>GND</td> </tr> <tr> <td>2</td> <td>SDA(1.8V)</td> </tr> <tr> <td>3</td> <td>SCL(1.8V)</td> </tr> <tr> <td>4</td> <td>RESET(1.8V)</td> </tr> <tr> <td>5</td> <td>INT(1.8V)</td> </tr> <tr> <td>6</td> <td>VDD(2.8V)</td> </tr> </table>	PIN#	定义	1	GND	2	SDA(1.8V)	3	SCL(1.8V)	4	RESET(1.8V)	5	INT(1.8V)	6	VDD(2.8V)																																																																																																																																																																																																																																																																																										
PIN#	定义																																																																																																																																																																																																																																																																																																												
1	GND																																																																																																																																																																																																																																																																																																												
2	SDA(1.8V)																																																																																																																																																																																																																																																																																																												
3	SCL(1.8V)																																																																																																																																																																																																																																																																																																												
4	RESET(1.8V)																																																																																																																																																																																																																																																																																																												
5	INT(1.8V)																																																																																																																																																																																																																																																																																																												
6	VDD(2.8V)																																																																																																																																																																																																																																																																																																												
<p>Backlight LED Circuit LED电路 (3#7-21)</p> <p>VF=9.6V(TYP), IF=140MA</p>					<table border="1" style="width:100%; border-collapse: collapse;"> <tr> <td>74</td> <td>Title:</td> <td>LCM</td> <td>Kingtech Group Co., Ltd.</td> </tr> <tr> <td>73</td> <td>变更 (Rev):</td> <td>01</td> <td>设计: JACZT300</td> </tr> <tr> <td>72</td> <td>变更 (Rev):</td> <td>01</td> <td>审核: JACZT300</td> </tr> <tr> <td>71</td> <td>变更 (Rev):</td> <td>01</td> <td>设计: JACZT300</td> </tr> <tr> <td>70</td> <td>变更 (Rev):</td> <td>01</td> <td>设计: JACZT300</td> </tr> <tr> <td>69</td> <td>变更 (Rev):</td> <td>01</td> <td>设计: JACZT300</td> </tr> <tr> <td>68</td> <td>变更 (Rev):</td> <td>01</td> <td>设计: JACZT300</td> </tr> <tr> <td>67</td> <td>变更 (Rev):</td> <td>01</td> <td>设计: JACZT300</td> </tr> <tr> <td>66</td> <td>变更 (Rev):</td> <td>01</td> <td>设计: JACZT300</td> </tr> <tr> <td>65</td> <td>变更 (Rev):</td> <td>01</td> <td>设计: JACZT300</td> </tr> <tr> <td>64</td> <td>变更 (Rev):</td> <td>01</td> <td>设计: JACZT300</td> </tr> <tr> <td>63</td> <td>变更 (Rev):</td> <td>01</td> <td>设计: JACZT300</td> </tr> <tr> <td>62</td> <td>变更 (Rev):</td> <td>01</td> <td>设计: JACZT300</td> </tr> <tr> <td>61</td> <td>变更 (Rev):</td> <td>01</td> <td>设计: JACZT300</td> </tr> <tr> <td>60</td> <td>变更 (Rev):</td> <td>01</td> <td>设计: JACZT300</td> </tr> <tr> <td>59</td> <td>变更 (Rev):</td> <td>01</td> <td>设计: JACZT300</td> </tr> <tr> <td>58</td> <td>变更 (Rev):</td> <td>01</td> <td>设计: JACZT300</td> </tr> <tr> <td>57</td> <td>变更 (Rev):</td> <td>01</td> <td>设计: JACZT300</td> </tr> <tr> <td>56</td> <td>变更 (Rev):</td> <td>01</td> <td>设计: JACZT300</td> </tr> <tr> <td>55</td> <td>变更 (Rev):</td> <td>01</td> <td>设计: JACZT300</td> </tr> <tr> <td>54</td> <td>变更 (Rev):</td> <td>01</td> <td>设计: JACZT300</td> </tr> <tr> <td>53</td> <td>变更 (Rev):</td> <td>01</td> <td>设计: JACZT300</td> </tr> <tr> <td>52</td> <td>变更 (Rev):</td> <td>01</td> <td>设计: JACZT300</td> </tr> <tr> <td>51</td> <td>变更 (Rev):</td> <td>01</td> <td>设计: JACZT300</td> </tr> <tr> <td>50</td> <td>变更 (Rev):</td> <td>01</td> <td>设计: JACZT300</td> </tr> <tr> <td>49</td> <td>变更 (Rev):</td> <td>01</td> <td>设计: JACZT300</td> </tr> <tr> <td>48</td> <td>变更 (Rev):</td> <td>01</td> <td>设计: JACZT300</td> </tr> <tr> <td>47</td> <td>变更 (Rev):</td> <td>01</td> <td>设计: JACZT300</td> </tr> <tr> <td>46</td> <td>变更 (Rev):</td> <td>01</td> <td>设计: JACZT300</td> </tr> <tr> <td>45</td> <td>变更 (Rev):</td> <td>01</td> <td>设计: JACZT300</td> </tr> <tr> <td>44</td> <td>变更 (Rev):</td> <td>01</td> <td>设计: JACZT300</td> </tr> <tr> <td>43</td> <td>变更 (Rev):</td> <td>01</td> <td>设计: JACZT300</td> </tr> <tr> <td>42</td> <td>变更 (Rev):</td> <td>01</td> <td>设计: JACZT300</td> </tr> <tr> <td>41</td> <td>变更 (Rev):</td> <td>01</td> <td>设计: JACZT300</td> </tr> <tr> <td>40</td> <td>变更 (Rev):</td> <td>01</td> <td>设计: JACZT300</td> </tr> <tr> <td>39</td> <td>变更 (Rev):</td> <td>01</td> <td>设计: JACZT300</td> </tr> <tr> <td>38</td> <td>变更 (Rev):</td> <td>01</td> <td>设计: JACZT300</td> </tr> <tr> <td>37</td> <td>变更 (Rev):</td> <td>01</td> <td>设计: JACZT300</td> </tr> <tr> <td>36</td> <td>变更 (Rev):</td> <td>01</td> <td>设计: JACZT300</td> </tr> <tr> <td>35</td> <td>变更 (Rev):</td> <td>01</td> <td>设计: JACZT300</td> </tr> <tr> <td>34</td> <td>变更 (Rev):</td> <td>01</td> <td>设计: JACZT300</td> </tr> <tr> <td>33</td> <td>变更 (Rev):</td> <td>01</td> <td>设计: JACZT300</td> </tr> <tr> <td>32</td> <td>变更 (Rev):</td> <td>01</td> <td>设计: JACZT300</td> </tr> <tr> <td>31</td> <td>变更 (Rev):</td> <td>01</td> <td>设计: JACZT300</td> </tr> <tr> <td>30</td> <td>变更 (Rev):</td> <td>01</td> <td>设计: JACZT300</td> </tr> <tr> <td>29</td> <td>变更 (Rev):</td> <td>01</td> <td>设计: JACZT300</td> </tr> <tr> <td>28</td> <td>变更 (Rev):</td> <td>01</td> <td>设计: JACZT300</td> </tr> <tr> <td>27</td> <td>变更 (Rev):</td> <td>01</td> <td>设计: JACZT300</td> </tr> <tr> <td>26</td> <td>变更 (Rev):</td> <td>01</td> <td>设计: JACZT300</td> </tr> <tr> <td>25</td> <td>变更 (Rev):</td> <td>01</td> <td>设计: JACZT300</td> </tr> <tr> <td>24</td> <td>变更 (Rev):</td> <td>01</td> <td>设计: JACZT300</td> </tr> <tr> <td>23</td> <td>变更 (Rev):</td> <td>01</td> <td>设计: JACZT300</td> </tr> <tr> <td>22</td> <td>变更 (Rev):</td> <td>01</td> <td>设计: JACZT300</td> </tr> <tr> <td>21</td> <td>变更 (Rev):</td> <td>01</td> <td>设计: JACZT300</td> </tr> <tr> <td>20</td> <td>变更 (Rev):</td> <td>01</td> <td>设计: JACZT300</td> </tr> <tr> <td>19</td> <td>变更 (Rev):</td> <td>01</td> <td>设计: JACZT300</td> </tr> <tr> <td>18</td> <td>变更 (Rev):</td> <td>01</td> <td>设计: JACZT300</td> </tr> <tr> <td>17</td> <td>变更 (Rev):</td> <td>01</td> <td>设计: JACZT300</td> </tr> <tr> <td>16</td> <td>变更 (Rev):</td> <td>01</td> <td>设计: JACZT300</td> </tr> <tr> <td>15</td> <td>变更 (Rev):</td> <td>01</td> <td>设计: JACZT300</td> </tr> <tr> <td>14</td> <td>变更 (Rev):</td> <td>01</td> <td>设计: JACZT300</td> </tr> <tr> <td>13</td> <td>变更 (Rev):</td> <td>01</td> <td>设计: JACZT300</td> </tr> <tr> <td>12</td> <td>变更 (Rev):</td> <td>01</td> <td>设计: JACZT300</td> </tr> <tr> <td>11</td> <td>变更 (Rev):</td> <td>01</td> <td>设计: JACZT300</td> </tr> <tr> <td>10</td> <td>变更 (Rev):</td> <td>01</td> <td>设计: JACZT300</td> </tr> <tr> <td>9</td> <td>变更 (Rev):</td> <td>01</td> <td>设计: JACZT300</td> </tr> <tr> <td>8</td> <td>变更 (Rev):</td> <td>01</td> <td>设计: JACZT300</td> </tr> <tr> <td>7</td> <td>变更 (Rev):</td> <td>01</td> <td>设计: JACZT300</td> </tr> <tr> <td>6</td> <td>变更 (Rev):</td> <td>01</td> <td>设计: JACZT300</td> </tr> <tr> <td>5</td> <td>变更 (Rev):</td> <td>01</td> <td>设计: JACZT300</td> </tr> <tr> <td>4</td> <td>变更 (Rev):</td> <td>01</td> <td>设计: JACZT300</td> </tr> <tr> <td>3</td> <td>变更 (Rev):</td> <td>01</td> <td>设计: JACZT300</td> </tr> <tr> <td>2</td> <td>变更 (Rev):</td> <td>01</td> <td>设计: JACZT300</td> </tr> <tr> <td>1</td> <td>变更 (Rev):</td> <td>01</td> <td>设计: JACZT300</td> </tr> </table>	74	Title:	LCM	Kingtech Group Co., Ltd.	73	变更 (Rev):	01	设计: JACZT300	72	变更 (Rev):	01	审核: JACZT300	71	变更 (Rev):	01	设计: JACZT300	70	变更 (Rev):	01	设计: JACZT300	69	变更 (Rev):	01	设计: JACZT300	68	变更 (Rev):	01	设计: JACZT300	67	变更 (Rev):	01	设计: JACZT300	66	变更 (Rev):	01	设计: JACZT300	65	变更 (Rev):	01	设计: JACZT300	64	变更 (Rev):	01	设计: JACZT300	63	变更 (Rev):	01	设计: JACZT300	62	变更 (Rev):	01	设计: JACZT300	61	变更 (Rev):	01	设计: JACZT300	60	变更 (Rev):	01	设计: JACZT300	59	变更 (Rev):	01	设计: JACZT300	58	变更 (Rev):	01	设计: JACZT300	57	变更 (Rev):	01	设计: JACZT300	56	变更 (Rev):	01	设计: JACZT300	55	变更 (Rev):	01	设计: JACZT300	54	变更 (Rev):	01	设计: JACZT300	53	变更 (Rev):	01	设计: JACZT300	52	变更 (Rev):	01	设计: JACZT300	51	变更 (Rev):	01	设计: JACZT300	50	变更 (Rev):	01	设计: JACZT300	49	变更 (Rev):	01	设计: JACZT300	48	变更 (Rev):	01	设计: JACZT300	47	变更 (Rev):	01	设计: JACZT300	46	变更 (Rev):	01	设计: JACZT300	45	变更 (Rev):	01	设计: JACZT300	44	变更 (Rev):	01	设计: JACZT300	43	变更 (Rev):	01	设计: JACZT300	42	变更 (Rev):	01	设计: JACZT300	41	变更 (Rev):	01	设计: JACZT300	40	变更 (Rev):	01	设计: JACZT300	39	变更 (Rev):	01	设计: JACZT300	38	变更 (Rev):	01	设计: JACZT300	37	变更 (Rev):	01	设计: JACZT300	36	变更 (Rev):	01	设计: JACZT300	35	变更 (Rev):	01	设计: JACZT300	34	变更 (Rev):	01	设计: JACZT300	33	变更 (Rev):	01	设计: JACZT300	32	变更 (Rev):	01	设计: JACZT300	31	变更 (Rev):	01	设计: JACZT300	30	变更 (Rev):	01	设计: JACZT300	29	变更 (Rev):	01	设计: JACZT300	28	变更 (Rev):	01	设计: JACZT300	27	变更 (Rev):	01	设计: JACZT300	26	变更 (Rev):	01	设计: JACZT300	25	变更 (Rev):	01	设计: JACZT300	24	变更 (Rev):	01	设计: JACZT300	23	变更 (Rev):	01	设计: JACZT300	22	变更 (Rev):	01	设计: JACZT300	21	变更 (Rev):	01	设计: JACZT300	20	变更 (Rev):	01	设计: JACZT300	19	变更 (Rev):	01	设计: JACZT300	18	变更 (Rev):	01	设计: JACZT300	17	变更 (Rev):	01	设计: JACZT300	16	变更 (Rev):	01	设计: JACZT300	15	变更 (Rev):	01	设计: JACZT300	14	变更 (Rev):	01	设计: JACZT300	13	变更 (Rev):	01	设计: JACZT300	12	变更 (Rev):	01	设计: JACZT300	11	变更 (Rev):	01	设计: JACZT300	10	变更 (Rev):	01	设计: JACZT300	9	变更 (Rev):	01	设计: JACZT300	8	变更 (Rev):	01	设计: JACZT300	7	变更 (Rev):	01	设计: JACZT300	6	变更 (Rev):	01	设计: JACZT300	5	变更 (Rev):	01	设计: JACZT300	4	变更 (Rev):	01	设计: JACZT300	3	变更 (Rev):	01	设计: JACZT300	2	变更 (Rev):	01	设计: JACZT300	1	变更 (Rev):	01	设计: JACZT300
74	Title:	LCM	Kingtech Group Co., Ltd.																																																																																																																																																																																																																																																																																																										
73	变更 (Rev):	01	设计: JACZT300																																																																																																																																																																																																																																																																																																										
72	变更 (Rev):	01	审核: JACZT300																																																																																																																																																																																																																																																																																																										
71	变更 (Rev):	01	设计: JACZT300																																																																																																																																																																																																																																																																																																										
70	变更 (Rev):	01	设计: JACZT300																																																																																																																																																																																																																																																																																																										
69	变更 (Rev):	01	设计: JACZT300																																																																																																																																																																																																																																																																																																										
68	变更 (Rev):	01	设计: JACZT300																																																																																																																																																																																																																																																																																																										
67	变更 (Rev):	01	设计: JACZT300																																																																																																																																																																																																																																																																																																										
66	变更 (Rev):	01	设计: JACZT300																																																																																																																																																																																																																																																																																																										
65	变更 (Rev):	01	设计: JACZT300																																																																																																																																																																																																																																																																																																										
64	变更 (Rev):	01	设计: JACZT300																																																																																																																																																																																																																																																																																																										
63	变更 (Rev):	01	设计: JACZT300																																																																																																																																																																																																																																																																																																										
62	变更 (Rev):	01	设计: JACZT300																																																																																																																																																																																																																																																																																																										
61	变更 (Rev):	01	设计: JACZT300																																																																																																																																																																																																																																																																																																										
60	变更 (Rev):	01	设计: JACZT300																																																																																																																																																																																																																																																																																																										
59	变更 (Rev):	01	设计: JACZT300																																																																																																																																																																																																																																																																																																										
58	变更 (Rev):	01	设计: JACZT300																																																																																																																																																																																																																																																																																																										
57	变更 (Rev):	01	设计: JACZT300																																																																																																																																																																																																																																																																																																										
56	变更 (Rev):	01	设计: JACZT300																																																																																																																																																																																																																																																																																																										
55	变更 (Rev):	01	设计: JACZT300																																																																																																																																																																																																																																																																																																										
54	变更 (Rev):	01	设计: JACZT300																																																																																																																																																																																																																																																																																																										
53	变更 (Rev):	01	设计: JACZT300																																																																																																																																																																																																																																																																																																										
52	变更 (Rev):	01	设计: JACZT300																																																																																																																																																																																																																																																																																																										
51	变更 (Rev):	01	设计: JACZT300																																																																																																																																																																																																																																																																																																										
50	变更 (Rev):	01	设计: JACZT300																																																																																																																																																																																																																																																																																																										
49	变更 (Rev):	01	设计: JACZT300																																																																																																																																																																																																																																																																																																										
48	变更 (Rev):	01	设计: JACZT300																																																																																																																																																																																																																																																																																																										
47	变更 (Rev):	01	设计: JACZT300																																																																																																																																																																																																																																																																																																										
46	变更 (Rev):	01	设计: JACZT300																																																																																																																																																																																																																																																																																																										
45	变更 (Rev):	01	设计: JACZT300																																																																																																																																																																																																																																																																																																										
44	变更 (Rev):	01	设计: JACZT300																																																																																																																																																																																																																																																																																																										
43	变更 (Rev):	01	设计: JACZT300																																																																																																																																																																																																																																																																																																										
42	变更 (Rev):	01	设计: JACZT300																																																																																																																																																																																																																																																																																																										
41	变更 (Rev):	01	设计: JACZT300																																																																																																																																																																																																																																																																																																										
40	变更 (Rev):	01	设计: JACZT300																																																																																																																																																																																																																																																																																																										
39	变更 (Rev):	01	设计: JACZT300																																																																																																																																																																																																																																																																																																										
38	变更 (Rev):	01	设计: JACZT300																																																																																																																																																																																																																																																																																																										
37	变更 (Rev):	01	设计: JACZT300																																																																																																																																																																																																																																																																																																										
36	变更 (Rev):	01	设计: JACZT300																																																																																																																																																																																																																																																																																																										
35	变更 (Rev):	01	设计: JACZT300																																																																																																																																																																																																																																																																																																										
34	变更 (Rev):	01	设计: JACZT300																																																																																																																																																																																																																																																																																																										
33	变更 (Rev):	01	设计: JACZT300																																																																																																																																																																																																																																																																																																										
32	变更 (Rev):	01	设计: JACZT300																																																																																																																																																																																																																																																																																																										
31	变更 (Rev):	01	设计: JACZT300																																																																																																																																																																																																																																																																																																										
30	变更 (Rev):	01	设计: JACZT300																																																																																																																																																																																																																																																																																																										
29	变更 (Rev):	01	设计: JACZT300																																																																																																																																																																																																																																																																																																										
28	变更 (Rev):	01	设计: JACZT300																																																																																																																																																																																																																																																																																																										
27	变更 (Rev):	01	设计: JACZT300																																																																																																																																																																																																																																																																																																										
26	变更 (Rev):	01	设计: JACZT300																																																																																																																																																																																																																																																																																																										
25	变更 (Rev):	01	设计: JACZT300																																																																																																																																																																																																																																																																																																										
24	变更 (Rev):	01	设计: JACZT300																																																																																																																																																																																																																																																																																																										
23	变更 (Rev):	01	设计: JACZT300																																																																																																																																																																																																																																																																																																										
22	变更 (Rev):	01	设计: JACZT300																																																																																																																																																																																																																																																																																																										
21	变更 (Rev):	01	设计: JACZT300																																																																																																																																																																																																																																																																																																										
20	变更 (Rev):	01	设计: JACZT300																																																																																																																																																																																																																																																																																																										
19	变更 (Rev):	01	设计: JACZT300																																																																																																																																																																																																																																																																																																										
18	变更 (Rev):	01	设计: JACZT300																																																																																																																																																																																																																																																																																																										
17	变更 (Rev):	01	设计: JACZT300																																																																																																																																																																																																																																																																																																										
16	变更 (Rev):	01	设计: JACZT300																																																																																																																																																																																																																																																																																																										
15	变更 (Rev):	01	设计: JACZT300																																																																																																																																																																																																																																																																																																										
14	变更 (Rev):	01	设计: JACZT300																																																																																																																																																																																																																																																																																																										
13	变更 (Rev):	01	设计: JACZT300																																																																																																																																																																																																																																																																																																										
12	变更 (Rev):	01	设计: JACZT300																																																																																																																																																																																																																																																																																																										
11	变更 (Rev):	01	设计: JACZT300																																																																																																																																																																																																																																																																																																										
10	变更 (Rev):	01	设计: JACZT300																																																																																																																																																																																																																																																																																																										
9	变更 (Rev):	01	设计: JACZT300																																																																																																																																																																																																																																																																																																										
8	变更 (Rev):	01	设计: JACZT300																																																																																																																																																																																																																																																																																																										
7	变更 (Rev):	01	设计: JACZT300																																																																																																																																																																																																																																																																																																										
6	变更 (Rev):	01	设计: JACZT300																																																																																																																																																																																																																																																																																																										
5	变更 (Rev):	01	设计: JACZT300																																																																																																																																																																																																																																																																																																										
4	变更 (Rev):	01	设计: JACZT300																																																																																																																																																																																																																																																																																																										
3	变更 (Rev):	01	设计: JACZT300																																																																																																																																																																																																																																																																																																										
2	变更 (Rev):	01	设计: JACZT300																																																																																																																																																																																																																																																																																																										
1	变更 (Rev):	01	设计: JACZT300																																																																																																																																																																																																																																																																																																										



3. Pin Description

LCM PIN

Pin NO.	Symbol	Function
1	VDD3.3V	Power supply 3.3V
2	VDD3.3V	Power supply 3.3V
3	RESET	Hardware reset pin
4	GND	Ground
5	MIPI-D0-	DSI_D0- are differential data signal line
6	MIPI-D0+	DSI_D0+ are differential data signal line
7	GND	Ground
8	MIPI-D1-	DSI_D1- are differential data signal line
9	MIPI-D1+	DSI_D1+ are differential data signal line
10	GND	Ground
11	MIPI-CLK-	DSI_CLK+ are differential data signal line
12	MIPI-CLK+	DSI_CLK+ are differential data signal line
13	GND	Ground
14	MIPI-D2-	DSI_D2- are differential data signal line
15	MIPI-D2+	DSI_D2+ are differential data signal line
16	GND	Ground
17	MIPI-D3-	DSI_D3- are differential data signal line
18	MIPI-D3+	DSI_D3+ are differential data signal line
19	GND	Ground
20	PWMO	PWM control the LED backlight
21	GND	Ground
22	LED-	Backlight-
23	LED-	Backlight-
24	LED+	Backlight+
25	LED+	Backlight+

**CTP PIN**

1	GND	L	Ground
2	SDA	H/L	Serial data input pin
3	SCL	H/L	Serial clock input
4	REST	H/L	Hardware reset pin
5	INT	H/L	Interrupt pin
6	VCC	H/L	Power supply 2.8V



4. ELECTRICAL CHARACTERISTICS

4.1 ABSOLUTE MAXIMUM RATINGS

Item	Symbol	Values		Unit	Remark
		Min	Max.		
Supply Voltage for Logic circuit	VDDIO	-	-	V	
Supply Voltage for analog circuit	Vcc	3.0	3.6	V	

4.2 DC ELECTRICAL CHARACTERISTICS

4.2.1 OPERATING CONDITIONS

Typical Operating Conditions (Ta=25°C)

Item	Symbol	Values			Unit	Remark
		Min	Typ	Max.		
Power Supply	Vcc	3.0	3.3	3.6	V	
Power Supply	VDDIO	-	-	-	V	
Normal mode Current consumption	Icc	-	200	-	mA	VCC=3.3V
TFT Gate ON Voltage	VGH	-	-	-	V	
TFT Gate OFF Voltage	VGL	-	-	-	V	

4.2.2 BACKLIGHT UNIT (GND=0V)

Item	Symbol	Values			Unit	Remark
		Min	Typ	Max.		
Forward supply Voltage	Vf	-	9.6	-	V	
Forward supply Current	If	-	140	-	mA	
LCM+CTP Luminance	L _V	330	380	-	cd/m ²	I _B =140mA
Uniformity	/	80			%	-



4.3 MIPI Interface Characteristics

7.1.2. Power-up Sequence Example

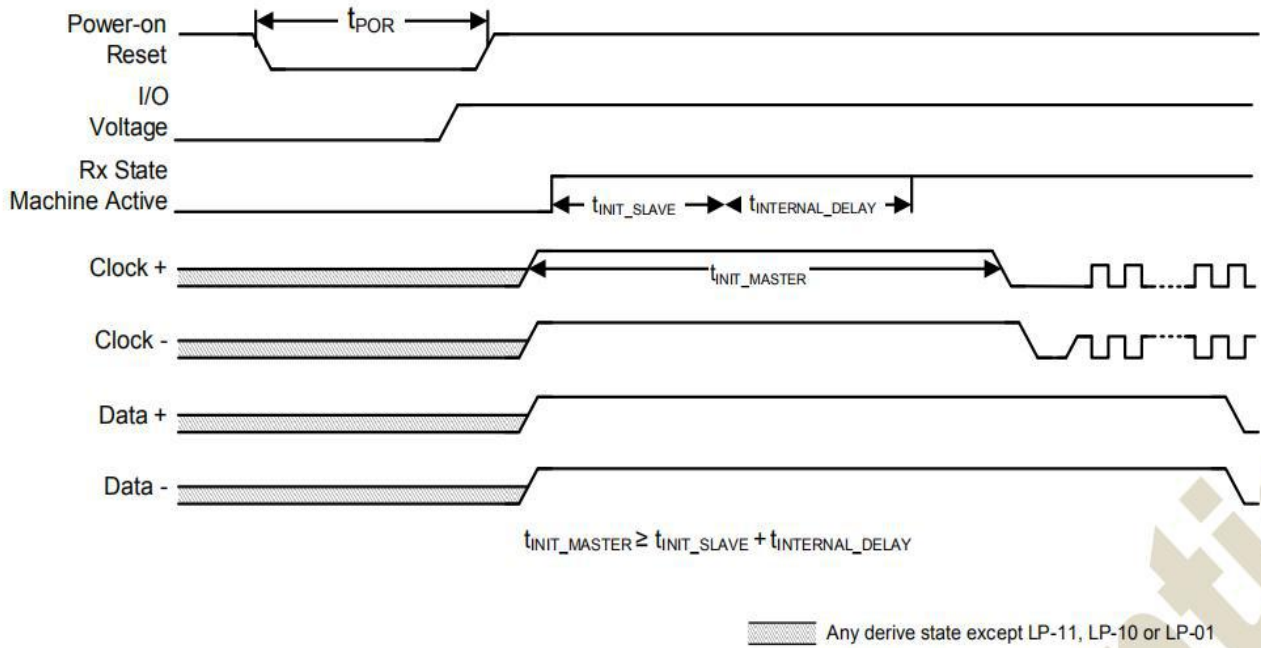



5. OPTICAL CHARACTERISTICS

(LCD MONOMER PARAMETERS)

Parameter		Symbol	Condition	Min	Typ	Max	Unit	Remark
Viewing Angle	Horizontal	Θ_3	CR > 10		85	-	Deg.	Note 1、 6
		Θ_9			85	-	Deg.	
	Vertical	Θ_{12}			85	-	Deg.	
		Θ_6			85	-	Deg.	
Color Gamut			-	50	60	-	%	NTSC
Contrast ratio		CR		600:1	800:1	-		Note 2、 6
Trans.		-		-	4.6	-	%	Note 3、 6
Reproduction of color	White	W_x	$\Theta = 0^\circ$ (Center) Normal Viewing Angle	TYP. - 0.03	0.297	TYP. + 0.03		Note 4、 6
		W_y			0.317			
	Red	R_x			0.616			
		R_y			0.356			
	Green	G_x			0.331			
		G_y			0.599			
	Blue	B_x			0.155			
		B_y			0.088			
Response Time		T_g		-	-	35	ms	Note 5、 6
Gamma Scale				2.0	2.2	2.4		Note 6



Note :

1. Viewing angle is the angle at which the contrast ratio is greater than 10. The viewing are determined for the horizontal or 3, 9 o'clock direction and the vertical or 6, 12 o'clock direction with respect to the optical axis which is normal to the LCD surface.
2. Contrast measurements shall be made at viewing angle of $\theta=0^\circ$ and at the center of the LCD surface. Luminance shall be measured with all pixels in the view field set first to white, then to the dark (black) state. (See FIGURE 1 shown in Appendix) Luminance Contrast Ratio (CR) is defined mathematically.

$$CR = \frac{\text{Luminance when displaying a white raster}}{\text{Luminance when displaying a black raster}}$$

3. Center Luminance of white is defined as luminance values of center point of the LCD surface. Luminance shall be measured with all pixels in the view field set first to white. When the LED current is set at 20mA.
4. The color chromaticity coordinates specified in Table 7. shall be calculated from the spectral data measured with all pixels first in red, green, blue and white. Measurements shall be made at the center of the panel.
5. The electro-optical response time measurements shall be made as FIGURE 2 shown in Appendix by switching the "data" input signal ON and OFF. The times needed for the luminance to change from 10% to 90% is T_d , and 90% to 10% is T_r .
6. The listed optical specifications refer to the initial value of manufacture, but the condition of the specifications after long-term operation will not be warranted



Figure 1. Measurement Set Up

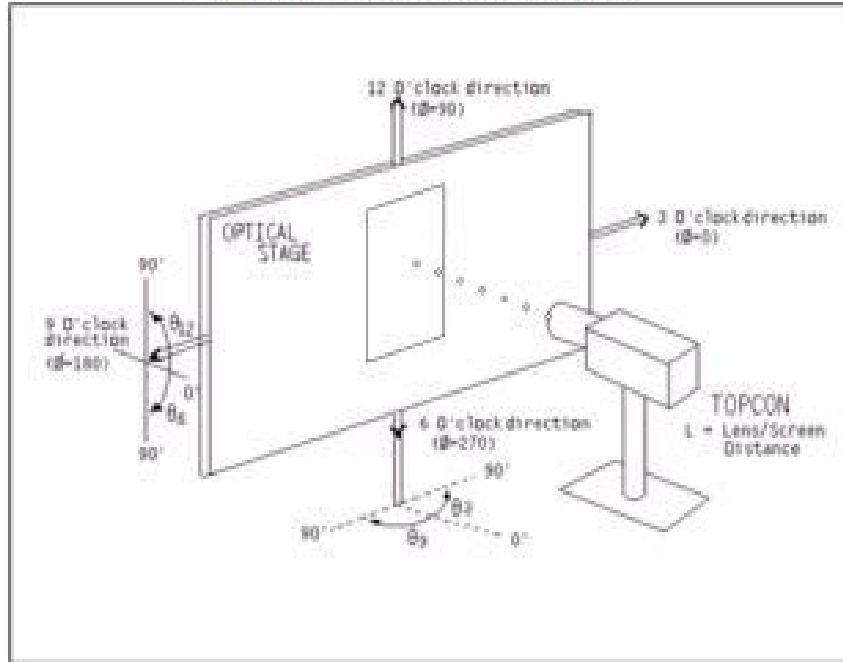
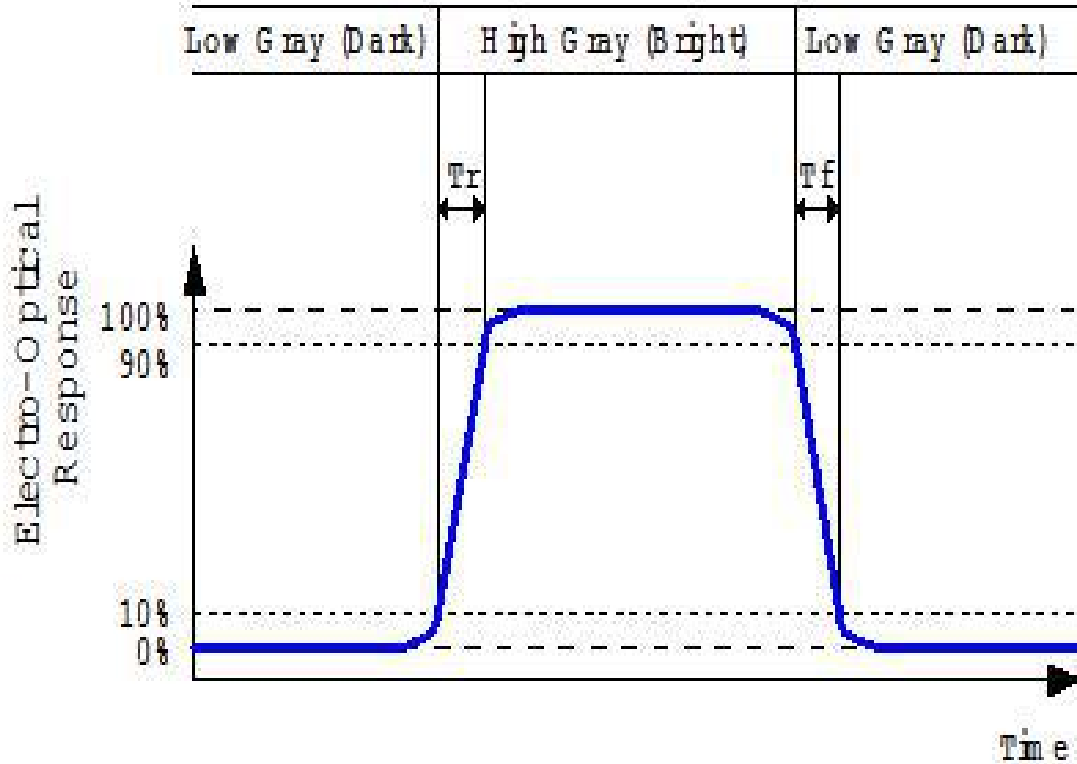

Figure 2. Response Time Testing





6. QUALITY SPECIFICATIONS

1. Inspection condition

1.1:Cosmetic inspection: viewing distance is about 30cm with bare eyes, and under an environment of 20~40W light intensity (600~1200LUX) , all directions for inspecting the sample should be within 45° against perpendicular line.

6.1.2:Function inspection: viewing distance is about 30cm with bare eyes, and under an environment of 300LUX light intensity, all directions for inspecting the sample should be within 45° against perpendicular line.

2. Definition of Inspection Item.

2.1 Definition of Inspection zone in I-touch module.

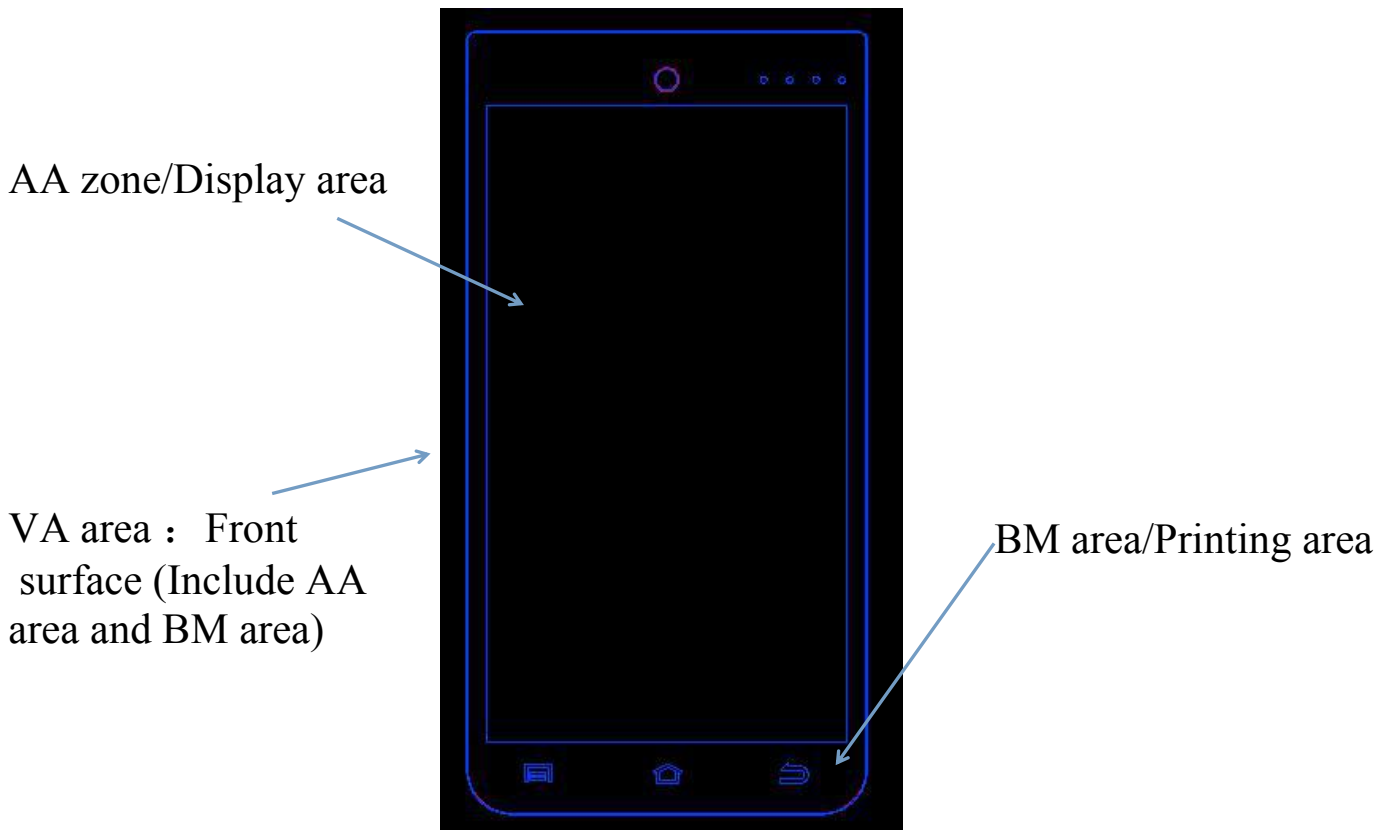

AA zone: Character/Display area

BM zone: Printing area



VA zone: Viewing area (AA area + BM area = viewing area)

3. Defect definition

3.1 Circular defect

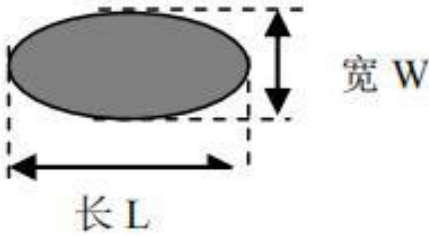

Diameter $\Phi = 1/2(L+W)$

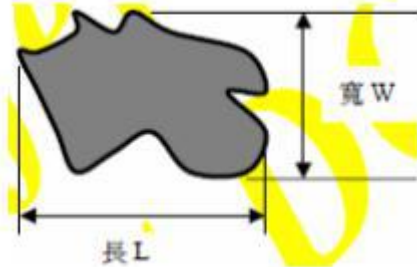

Diameter $\Phi = 1/2(L+W)$

3.2 Linear defect

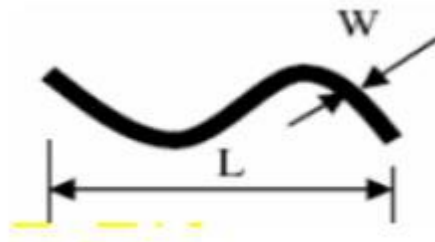

3.3 Pin hole

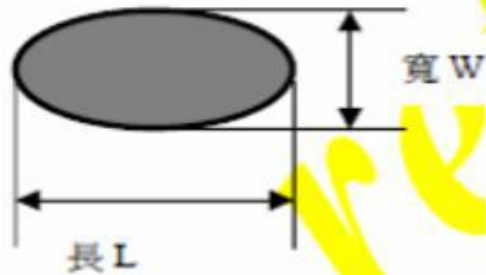
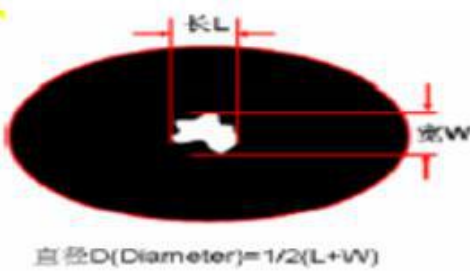

3.4 Zigzag

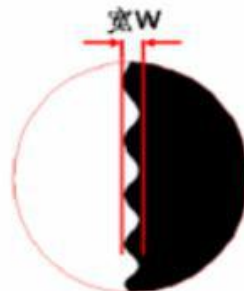
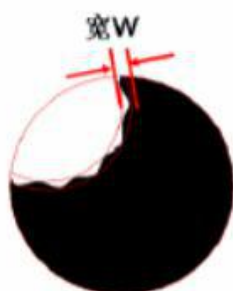



4. Inspection standards

4.1 Major defect

-Item -No	Items to be inspected	Inspection Standard	Classification of defects
4.1.1	All functional defects	1) No display 2) Display abnormally 3) Missing vertical, horizontal segment 4) Short circuit 5) Back-light no lighting, flickering and abnormal lighting. 6) Touch panel abnormal.	Major
4.1.2	Missing	Missing component	
4.1.3	Outline dimension	Overall outline dimension beyond the drawing is not allowed.	
4.1.4	LCD Mura	LCD Mura according to ND 5% keep out to determine, if keep out distance at 30cm be seen by eyes is NG, otherwise will be ok if invisible.	

4.2 Cosmetic defect

Item No	Items to be inspected	Inspection Standard	Classification of defects												
4.2.1	Dot defect	<table border="1"> <thead> <tr> <th>Zone</th> <th>VA area</th> </tr> </thead> <tbody> <tr> <td>Size(mm)</td> <td>Acceptable Qty</td> </tr> <tr> <td>$\Phi \leq 0.1$</td> <td>Ignore</td> </tr> <tr> <td>$0.10 < \Phi \leq 0.25$</td> <td>3</td> </tr> <tr> <td>$0.25 < \Phi \leq 0.30$</td> <td>1</td> </tr> <tr> <td>$0.30 < \Phi$</td> <td>0</td> </tr> </tbody> </table>	Zone	VA area	Size(mm)	Acceptable Qty	$\Phi \leq 0.1$	Ignore	$0.10 < \Phi \leq 0.25$	3	$0.25 < \Phi \leq 0.30$	1	$0.30 < \Phi$	0	Minor
		Zone	VA area												
		Size(mm)	Acceptable Qty												
		$\Phi \leq 0.1$	Ignore												
		$0.10 < \Phi \leq 0.25$	3												
$0.25 < \Phi \leq 0.30$	1														
$0.30 < \Phi$	0														



4.2.2	Dim Spots: Circle shaped and dim edged defects	Zone		VA area	Minor
		Size(mm)		Acceptable Qty	
		$\Phi \leq 0.20$		Ignore	
		$0.20 < \Phi \leq 0.40$		3	
		$0.40 < \Phi \leq 0.60$		2	
		$0.60 < \Phi$		0	
Item No	Items to be inspected	Inspection Standard			Classification of defects
4.2.3	Dent Spot Fish eye	Zone		VA area	Minor
		Size(mm)		Acceptable Qty	
		$\Phi \leq 0.10$		Ignore	
		$0.10 < \Phi \leq 0.20$		3	
		$0.20 < \Phi \leq 0.30$		2	
$0.30 < \Phi$		0			
4.2.4	Line defect	Zone		VA area	Minor
		Size(mm)		Acceptable Qty	
		L (Length)	W (Width)	Acceptable Qty	
		Ignore	$W \leq 0.03$	Ignore	
		$L \leq 5.0$	$0.03 < W \leq 0.05$	3	
		$L \leq 3.0$	$0.05 < W \leq 0.07$	1	
/	$0.07 < W$	Define as spot defect			





4.2.5	Scratch	<p>If the scratch can be seen after mobile phone cover assembling or in the operating condition, judged as the line defect of 4.2.4.</p> <p>If the scratch can be seen only in non-operating condition or some special angle, judged as the following table.</p>		Minor																		
		<table border="1"> <thead> <tr> <th colspan="2">Size (mm)</th> <th>VA area</th> </tr> </thead> <tbody> <tr> <td>L (Length)</td> <td>Acceptable Qty</td> <td>Acceptable Qty</td> </tr> <tr> <td>Ignore</td> <td>$W \leq 0.03$</td> <td>Ignore</td> </tr> <tr> <td>$5.0 < L \leq 10.0$</td> <td>$0.03 < W \leq 0.05$</td> <td>2</td> </tr> <tr> <td>$L \leq 5.0$</td> <td>$0.05 < W \leq 0.08$</td> <td>1</td> </tr> <tr> <td>/</td> <td>$W > 0.08$</td> <td>0</td> </tr> </tbody> </table>			Size (mm)		VA area	L (Length)	Acceptable Qty	Acceptable Qty	Ignore	$W \leq 0.03$	Ignore	$5.0 < L \leq 10.0$	$0.03 < W \leq 0.05$	2	$L \leq 5.0$	$0.05 < W \leq 0.08$	1	/	$W > 0.08$	0
		Size (mm)			VA area																	
		L (Length)	Acceptable Qty		Acceptable Qty																	
		Ignore	$W \leq 0.03$		Ignore																	
		$5.0 < L \leq 10.0$	$0.03 < W \leq 0.05$		2																	
		$L \leq 5.0$	$0.05 < W \leq 0.08$		1																	
		/	$W > 0.08$		0																	

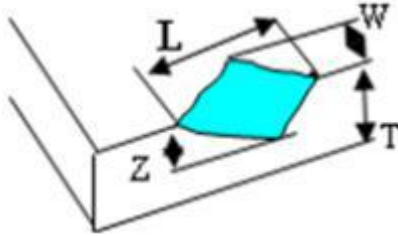
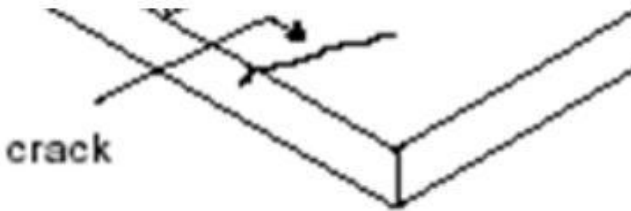

Item No	Items to be inspected	Inspection Standard	Classification of defect										
4.2.6	Bubble	<table border="1"> <thead> <tr> <th data-bbox="478 338 852 414">Zone</th> <th data-bbox="853 338 1224 414">VA area</th> </tr> <tr> <th data-bbox="478 416 852 470">Size(mm)</th> <th data-bbox="853 416 1224 470">Acceptable Qty</th> </tr> </thead> <tbody> <tr> <td data-bbox="478 472 852 526">$\Phi \leq 0.15$</td> <td data-bbox="853 472 1224 526">Ignore</td> </tr> <tr> <td data-bbox="478 528 852 582">$0.15 < \Phi \leq 0.25$</td> <td data-bbox="853 528 1224 582">2</td> </tr> <tr> <td data-bbox="478 584 852 638">$0.25 < \Phi$</td> <td data-bbox="853 584 1224 638">0</td> </tr> </tbody> </table>	Zone	VA area	Size(mm)	Acceptable Qty	$\Phi \leq 0.15$	Ignore	$0.15 < \Phi \leq 0.25$	2	$0.25 < \Phi$	0	
Zone	VA area												
Size(mm)	Acceptable Qty												
$\Phi \leq 0.15$	Ignore												
$0.15 < \Phi \leq 0.25$	2												
$0.25 < \Phi$	0												
4.2.7	Glass defect	<p data-bbox="478 707 906 745">4.2.7a Chip on corner or surface</p>  <table border="1" data-bbox="478 1070 1224 1227"> <thead> <tr> <th data-bbox="478 1070 730 1146">L(length)</th> <th data-bbox="732 1070 970 1146">W(width)</th> <th data-bbox="971 1070 1224 1146">Z(thickness)</th> </tr> </thead> <tbody> <tr> <td data-bbox="478 1149 730 1225">$L \leq 0.30$</td> <td data-bbox="732 1149 970 1225">$W \leq 0.20$</td> <td data-bbox="971 1149 1224 1225">T/2</td> </tr> </tbody> </table> <p data-bbox="478 1305 1136 1384">Notes: T=Lens thickness, $\Phi \leq 0.10$ ignore Acceptable Qty: Single edge $N \leq 2$, Total $N \leq 4$</p> <p data-bbox="478 1480 1010 1552">4.2.7b Cracks Cracks tend to break are not allowed.</p> 	L(length)	W(width)	Z(thickness)	$L \leq 0.30$	$W \leq 0.20$	T/2	Minor				
L(length)	W(width)	Z(thickness)											
$L \leq 0.30$	$W \leq 0.20$	T/2											



Item No	Items to be inspected	Inspection Standard	Classification of defect
4.2.8	Parts alignment	1) Not allow IC and FPC/heat-seal lead width is more than 50% beyond lead pattern. 2) Not allow chip or solder component is off center more than 50% of the pad outline.	Minor
4.2.9 view area/ printing area of front surface and view area of rear surface	LOGO Pattern	 <p>Dot: according to Dot spec. Thickness odds:</p> $\frac{ \text{Spec pattern width} - \text{Print pattern width} }{\text{Spec pattern width}} \times 100\% \leq 30\%$ <p>Drawing slant:</p> <p>Print pattern length $\leq 10\text{mm}$, slant angle $\leq 3^\circ$; $10\text{mm} < \text{Print pattern length} \leq 20\text{mm}$, slant angle $\leq 1.5^\circ$</p>  <p>Pattern serration: $H \leq 0.05 \text{ mm}$</p> <p>Pattern leak print/ error/overprint: not allowed</p> <p>Pattern break line: width $\leq 0.10 \text{ mm}$</p> <p>Logo pattern color windage / color thin: Follow the limit samples.</p>	Minor



Item No	Items to be inspected	Inspection Standard	Classification of defects
4.2.10 view area/printing area of front surface and view area of rear surface	IR hole(A)/ Light sensor hole(B)/ LED hole(C)	 <p>1. A.B.C hole must be according the transmittancy 2. Light leakage on A.B.C hole or follow the limited sample. 3. A.B.C hole (LED) hole only judge by black background, no need to check in the lamb condition.</p>	Minor
	Surface dirty	<p>1. Dirty can not be cleaned follow the dot spec. 2. Accept while the dirty can be cleaned. 3. The quality guarantee period of protective film is 3months, during the period, the spot or contamination is not allowed.</p>	
	Printing area Light leakage	<p>Follow the dot defect spec, MAX, Severity - see light leakage limit sample</p>	
	Ink overflow	<p>Visual inspection 30cm not allowed</p>	
	Color discordant	<p>Obvious color difference in the BM area is not allowed</p>	
	Icon scratch of printing logo area	<p>Icon printing logo area is not allow penetrability scratch</p>	



7.RELIABILITY

Test Item	Test Condition
High Temperature Operation	60°C for 96 hours
Low Temperature Operation	-10°C for 96 hours
High Temperature Storage	70°C for 96 hours
Low Temperature Storage	-20°C for 96 hours
High Temperature Operation Humidity Operation	60°C, 90%RH for 72 hours
Thermal Shock	-10°C (30min) ~+25°C (5min)~ +60°C (30min) for 10 cycles
Vibration Test (No Operation)	Frequency: 10~55Hz Amplitude:1.0mm Sweep Time: 11min Test Period: 6 Cycles for each direction of X, Y, Z
Static electricity test	Touch 4KV,air touch 8KV



8. HANDLING PRECAUTION

8.1 SAFETY

- (1) Do not swallow any liquid crystal, even if there is no proof that liquid crystal is poisonous.
- (2) If the LCD panel breaks, be careful not to get liquid crystal to touch your skin.
- (3) If skin is exposed to liquid crystal, wash the area thoroughly with alcohol or soap.

8.2 STORAGE CONDITIONS

- (1) Store the panel or module in a dark place where the temperature is $23\pm 5^{\circ}\text{C}$ and the humidity is below $50\pm 20\% \text{RH}$.
- (2) Store in anti-static electricity container.
- (3) Store in clean environment, free from dust, active gas, and solvent.
- (4) Do not place the module near organics solvents or corrosive gases.
- (5) Do not crush, shake, or jolt the module.

8.3 HANDLING PRECAUTIONS

- (1) Avoid static electricity which can damage the CMOS LSI.
- (2) The polarizing plate of the display is very fragile. So, please handle it very carefully.
- (3) Do not give external shock.
- (4) Do not apply excessive force on the surface.
- (5) Do not wipe the polarizing plate with a dry cloth, as it may easily scratch the surface of plate.
- (6) Do not use ketonic solvent & Aromatic solvent, use with a soft cloth soaked with a cleaning naphtha solvent.
- (7) Do not operate it above the absolute maximum rating.
- (8) Do not remove the panel or frame from the module.

8.4 WARRANTY

- 1) The period is within twelve months since the date of shipping out under normal using and storage conditions.
- 2) According to Kingtech TFT LCD quality standard, Kingtech will rework or exchange for functional defect goods since within one year.